

Filler SMALL-IN-ONE

24 filling valves



Proven technology designed for the small craft business, built on the ALL-IN-ONE platform.

Main features

- Glass bottles or cans can be handled in the same machine
- Tool free changeover in 20 minutes by 2 operators
- No compromises in quality

Simplified installation & maintenance

- Drive and gear transmission
- Compact design
- Shipped as one block on a single truck / HiCube container
- Ready for use 2 weeks after start of installation

Applications

- Beer
- RTD's
- Soft drinks (still & sparkling)
- Wine (still & sparkling)
- Water (still & sparkling)
- Juices (including fruit pulp, up to 1x6mm)

Filling temperature range

- 0° - 20°C

CO₂ content

- 0 - 8 gr/l

Formats

Cans

- Standard
- Sleek
- Slim

Glass bottles

- Diameter 50 - 90 mm
- Crown corks

Options

- ROPP / Aluminium screw cap
- Plastic screw cap

Configuration for crown corks and lids

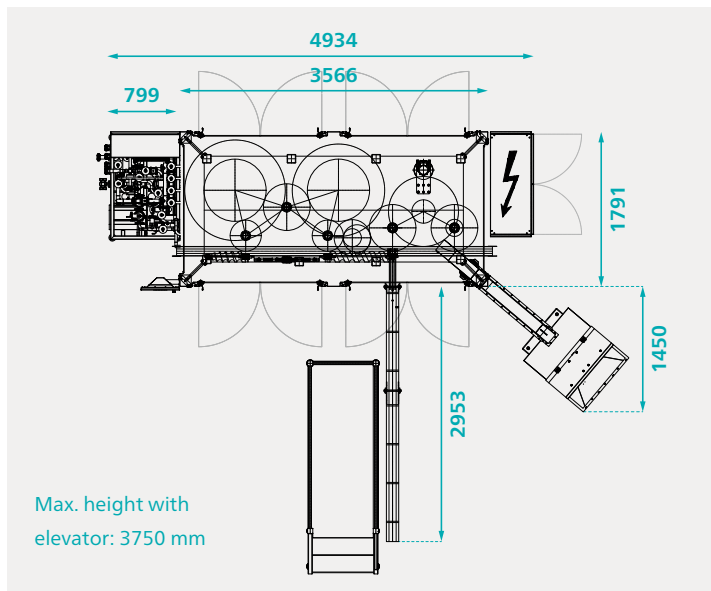

Configuration for crown corks and lids, ROPP caps

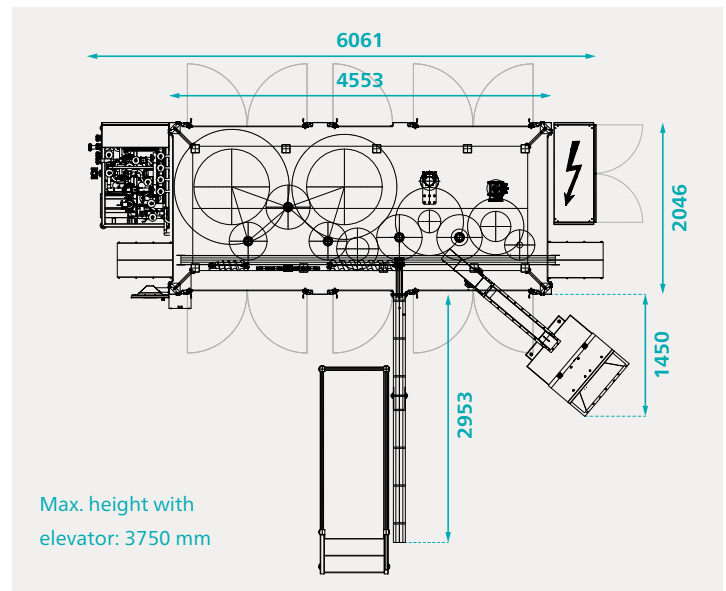

Capacities

Product	Filling temp. (°C)	CO ₂ content (g/L)	Filler nominal capacity (cph)	Container volume (ml)
Beer	4	5,5	7.500	330
(Pils, Lager)			6.000	500
Beer	15	5,5	6.500	330
(Pils, Lager)			5.000	500
Soft drinks	4	5,5	7.000	330
/ RTD			5.500	500
Soft drinks	15	5,5	6.000	330
/ RTD			5.000	500
Carbonated water	15-20	6,5	8.000	330
			6.500	500
Still water	20-25	0	8.000	330
			8.000	500
Still wine	20	2	8.000	250
			5.000	750
Sparkling wine	4-6	8	6.200	250
			2.800	750
Juice	90	0	8.000	250
			3.500	1000

Options and upgrades

- External flushing system with piping and nozzles for external cleaning
- Foaming system
- Platform for manual lid feeding
- Cap elevator
- Second capping turret complete with:
 - capping heads for ROPP cap
 - free places for future upgrade with plastic caps (can also be added after the machine is already installed)
- System for Hot-fill
- Simple cover with HEPA Filter

Basic scope

Item	Size 24
Orientation possible	L → R and R → L
Technical designation	VKR-E 24-24-4D/4K
Nr. of rinsing stations	24 universal grippers
Rinser Execution	2-channel rinsing (rinsing with disinfection + sterile water); pump not included
Nr. of filling valves	24
Filling system	Short vent tubes
Closing turret	Combination of: <ul style="list-style-type: none"> Crown cork - 1 cap type/size Seamer - 1 lid size/type
Nr. of capping heads	4
Nr. of seaming stations	4
Lid supply	Chute for manual loading (chute on 2,1 m height)
Software	B&R PLC & Control
Electrical specs	EU / CE
Accessories for filling beer	<ul style="list-style-type: none"> Vacuum pump Hot water injection Undercover gassing & bubble breaker
Format parts	<ul style="list-style-type: none"> 1 glass bottle with 1 type of crown cork 1 can type with 1 type of lid
Other	<ul style="list-style-type: none"> Bottle / can shower Water recirculation system from rinser to the bottle / can shower and vacuum pump